



BRUKERGUIDE FOR UTFORDRENDE BRUKSOMRÅDER INNEN LIMING/FUGING



Quality makes the pro.



Relekta AS

02.08.2011©Relekta AS • Tlf: 22 66 04 00 • E-post: post@novatech.as • www.novatech.as



INNHOLD:

Side 4 - 7 RENGJØRING

Side 8 - 23 BEARBEIDING

Side 24 - 30 PÅFØRING

Side 31 - 41 EGENSKAPER

Side 42 - 44 FINPUSSEN

Quality makes the pro.



Releka AS



Fugemasser og lim vil kun få den optimale varige heften når følgende forutsetninger er oppfylt:

- Underlaget er støvfritt, fettfritt og rent
- Underlag som i utgangspunktet har dårlig heftevne er bearbeidet
- Fugemassen/limet er påført på optimal måte
- Fugemassen/limet har de riktige egenskapene

Quality makes the pro.



Releka AS



RENGJØRING

Rengjøring er en forutsetning for optimal heft med fugemasser og lim. Underlag må være:

- Støvfritt
- Fettfritt
- Rent

Quality makes the pro.



Relekta AS



RENGJØRING

Gjør underlaget FRITT FOR STØV



Støv på underlaget = **Ingen heft!**



Børst eller tørk vekk støvet



Støvfritt underlag er klar til påføring



Perfekt heft!

Quality makes the pro.



Releka AS

02.08.2011©Releka AS • Tlf: 22 66 04 00 • E-post: post@novatech.as • www.novatech.as

Side 5



RENGJØRING

Gjør underlaget RENT og FETTFRITT

Organisk forurensning – bruk Foam7



Organisk forurensning på underlaget = **Ingen heft!**



Spray Foam7 over forurensningen



La Foam7 virke i minimum 20 sekunder. Etter virkning vil du se at Foam7-skummet har trukket til seg forurensningen



Tørk vekk skummet med en tørr klut - **Perfekt heft!**

Quality makes the pro.



Releka AS



RENGJØRING

Gjør underlaget RENT og FETTFRITT

Olje-/petroleumbasert forurensning – bruk Tec7-Cleaner



Olje-/petroleumbasert forurensning på underlaget = **Ingen heft!**



Spray Tec7-Cleaner over forurensningen



La Tec7-Cleaner virke



Tørk vekk forurensningen med en tørr klut - **Perfekt heft!**

Quality makes the pro.



Releka AS

02.08.2011©Releka AS • Tlf: 22 66 04 00 • E-post: post@novatech.as • www.novatech.as

Side 7



BEARBEIDING

Hvordan bearbeide underlaget for å få et bedre grunnlag for vedheft?

- Sliping
- Etsing
- Oppvarming
- Forsterking

Quality makes the pro.



Relekta AS



BEARBEIDING

SLIPING av glatte flater

Oljede forskalingplater



For glatt flate = **Ingen heft!**

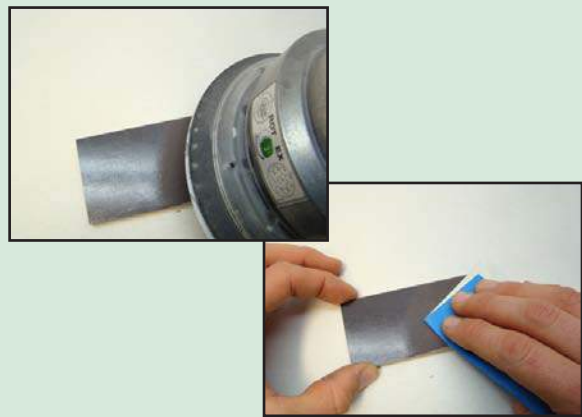

Slip/puss overflaten

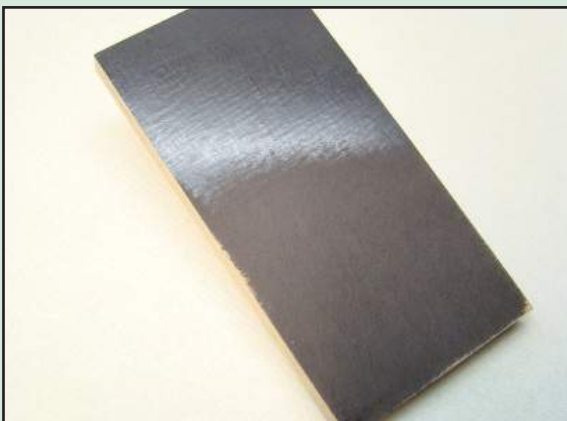

Resultat etter sliping/pussing er en ru overflate



Ru overflate - **Perfekt heft!**

Quality makes the pro.



Relekt AS

02.08.2011©Relekt AS • Tlf: 22 66 04 00 • E-post: post@novatech.as • www.novatech.as

Side 9



BEARBEIDING

SLIPING av glatte flater

Epoxybelegg (lakkerte flater)



For glatt flate = **Ingen heft!**

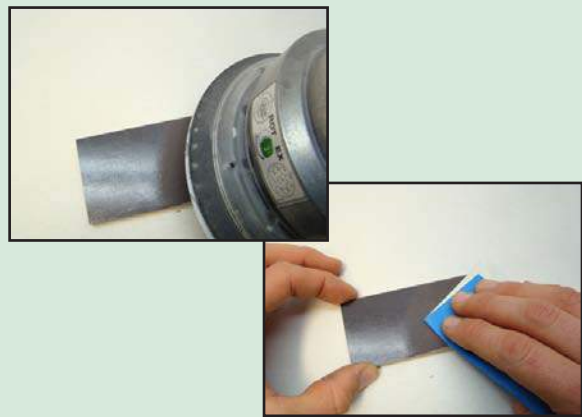

Slip/puss overflaten



Resultat etter sliping/pussing er en ru overflate

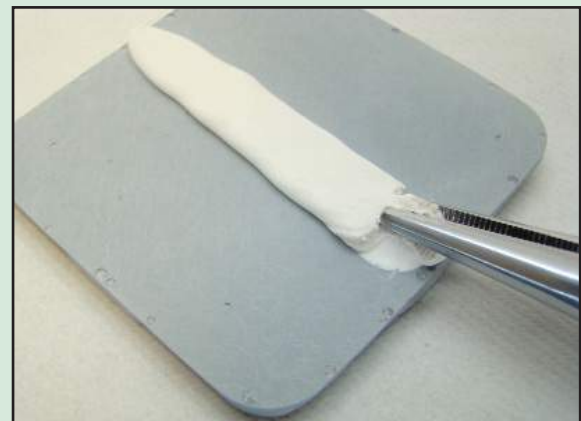

Ru overflate - **Perfekt heft!**

Quality makes the pro.



Releka AS



BEARBEIDING

ETSING av glatte flater

Pulverlakkerte flater (Industrilakkerte)



For glatt flate = **Ingen heft!**

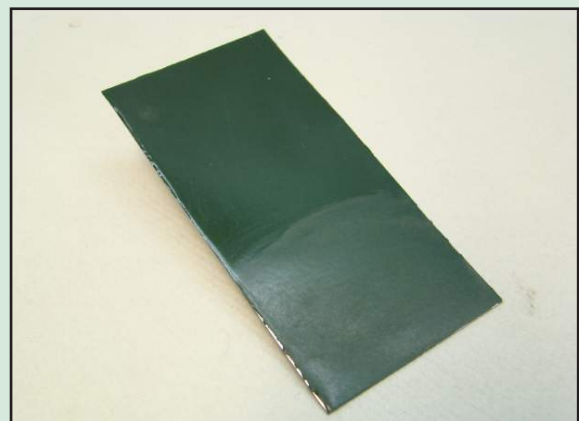

Bruk f.eks et etsende kjemikalie for å få en ru overflate



Ru overflate - **Perfekt heft!**

Quality makes the pro.



Relekta AS



BEARBEIDING

ETSING av glatte flater

Syntetiske materialer

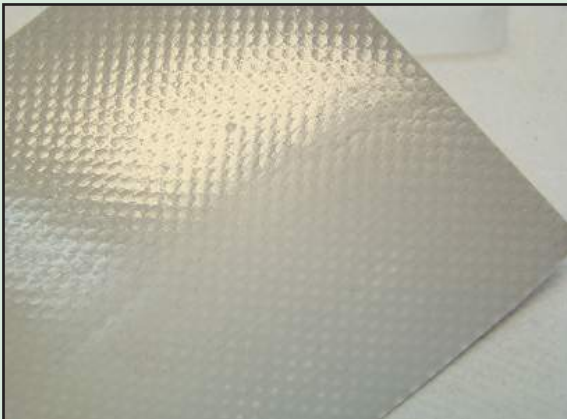

Ingen heft! – Bruk f.eks et etsende kjemikalie for å få en ru overflate



Ru overflate - **Perfekt heft!**

Gummi

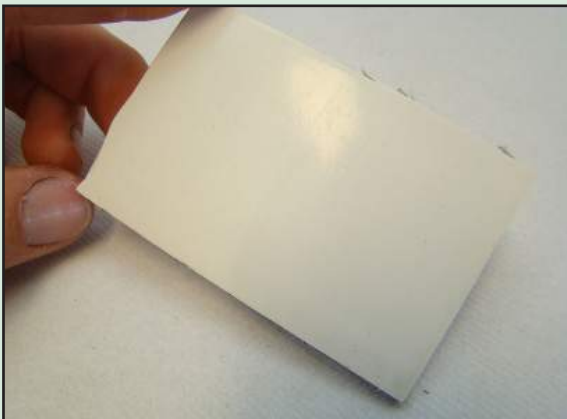

Ingen heft! – Bruk f.eks et etsende kjemikalie for å få en ru overflate



Ru overflate - **Perfekt heft!**

Quality makes the pro.



Releka AS



BEARBEIDING

OPPVARMING av vanskelige materialer

Vanskelig å lime på syntetiske materialer f.eks PP og PE plast



Ingen heft!



Varm opp overflaten



Spenningen i overflaten er endret - God heft!

Quality makes the pro.



Releka AS



BEARBEIDING

FORSTERKE øverste laget på overflaten

Murstein



Porøs overflate = **Ingen heft!**



Bruk primer



Påfør primer og la den tørke



Påføring av primer = **God heft!**

NB – primer må ikke inneholde silikon

Quality makes the pro.



Relekta AS



BEARBEIDING

FORSTERKE øverste laget på overflaten

Rust



Overflate med løse rustpartikler =
Ingen heft!



Bruk primer



Påfør primer og la den tørke



Påføring av primer = **God heft!**

NB – primer må ikke inneholde silikon

Quality makes the pro.



Releka AS



BEARBEIDING

FORSTERKE øverste laget på overflaten

Sand



Ingen heft!



Bruk primer



Perfekt heft!

NB – primer må ikke inneholde silikon

Quality makes the pro.



Relekt AS



BEARBEIDING

FORSTERKE øverste laget på overflaten

Trefiberplater



Løse trefiber = **Ingen heft!**



Bruk primer



Påfør primer og la den tørke



Påføring av primer = **God heft!**

NB – primer må ikke inneholde silikon

Quality makes the pro.



Relekta AS



BEARBEIDING

FORSTERKE øverste laget på overflaten

Massivt tre og harde tresorter med rikt oljeinnhold



Oljet/fet overflate = **Ingen heft!**



Bruk primer



Påfør primer og la den tørke



Påføring av primer = **God heft!**

NB – primer må ikke inneholde silikon

Quality makes the pro.



Releka AS



BEARBEIDING

FORSTERKE øverste laget på overflaten

Bløte blandingsprodukter – stoffer/tøy



Ingen heft!



Bruk primer

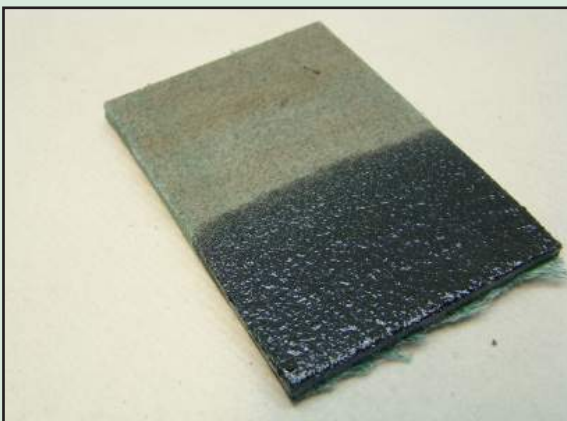

Påfør primer og la den tørke



Påføring av primer = God heft!

NB – primer må ikke inneholde silikon

Quality makes the pro.



Releka AS

02.08.2011©Releka AS • Tlf: 22 66 04 00 • E-post: post@novatech.as • www.novatech.as

Side 19



BEARBEIDING

FORSTERKE øverste laget på overflaten

Porebetong (Ytong)



Løst sammensatt produkt =
Ingen heft!



Bruk primer



Påfør primer og la den tørke



Påføring av primer = **God heft!**

NB – primer må ikke inneholde silikon

Quality makes the pro.



Relekta AS



BEARBEIDING

Noen overflater som har topplag med svak vedheft kan ikke forsterkes.

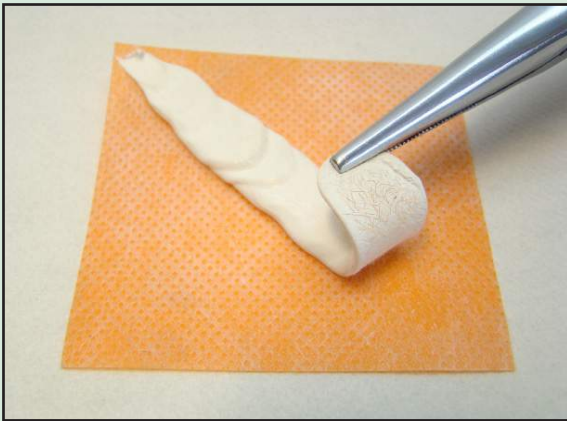

Eks. PVC-duk



Eks. overflate som sitter dårlig til underlag



Eks. strie

Quality makes the pro.



Relekta AS



BEARBEIDING

Noen overflater har dårlig eller til og med ingen vedheft.



**Ingen vedheft på Bitumen
(asfalt/oljeprodukter)!**



Roof7 kan i noen tilfeller benyttes
– test hvert enkelt tilfelle

Quality makes the pro.



Relekta AS



BEARBEIDING

Noen overflater har dårlig eller til og med ingen vedheft.

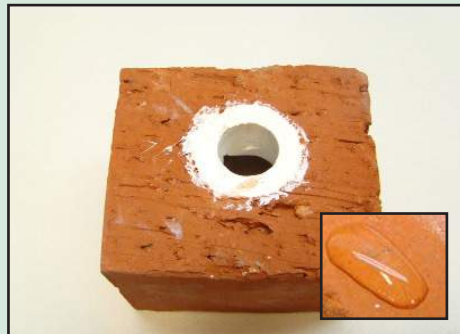

Problem f.eks
murstein med
rørgjennomføring
av PE eller PP plast
(PVC utgjør ingen
problem)



Bruk en tykk type
tape som har en
god heft på PE, PP
(plast)



Har god vedheft på
tape og murstein

Quality makes the pro.



Relekta AS



PÅFØRING

Hvordan påføre fugemasse på underlaget?

- Vertikalt
- Korrekt tykkelse
- Riktig patronspiss
- Fugedimmensjon
- Vedheft
- Optimal fugepistol

Quality makes the pro.



Relekta AS



PÅFØRING

RIKTIG påføring av fugemasse

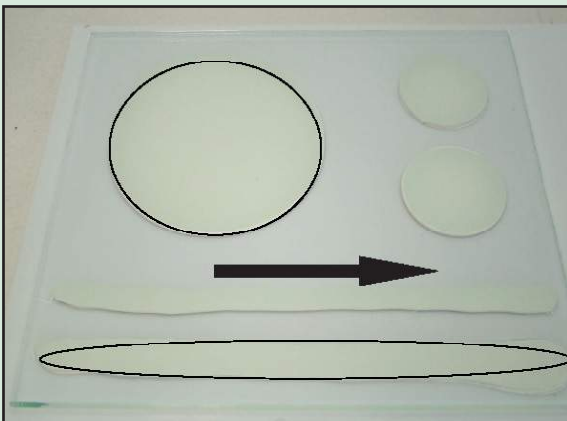

Legg aldri sirkler eller horisontale striper!

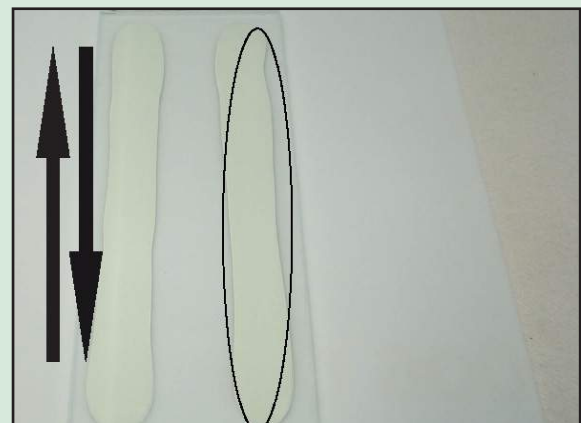

Legg alltid vertikale striper!

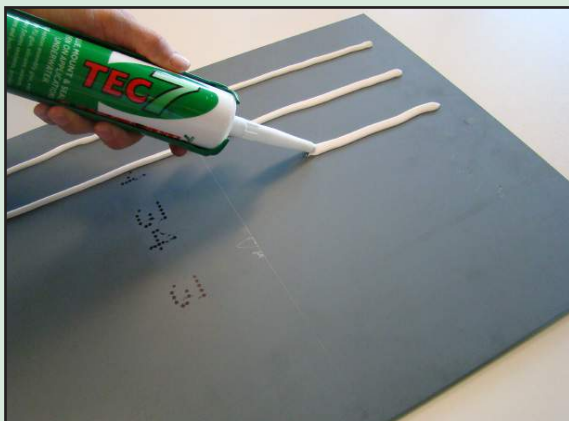

Quality makes the pro.



Releka AS



PÅFØRING

KORREKT TYKKELSE på fugemassen

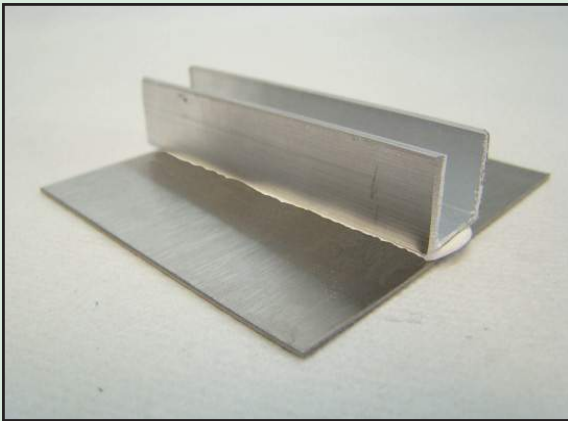

Bruk aldri for lite fugemasse!

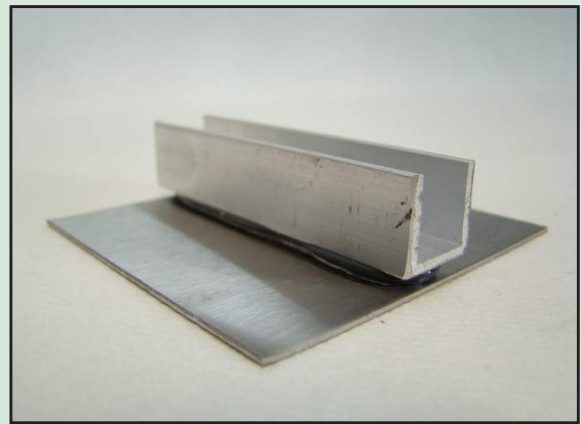

Bruk alltid nok fugemasse!

=

minimum 2 til 3 millimeter

Quality makes the pro.



Releka AS



PÅFØRING

Bruk riktig PATRONSPISS

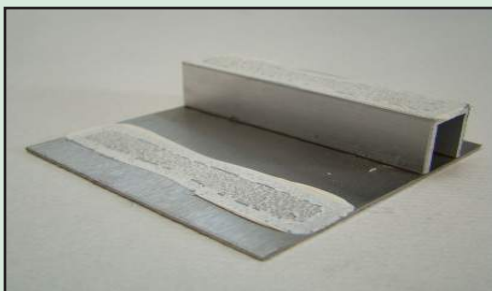
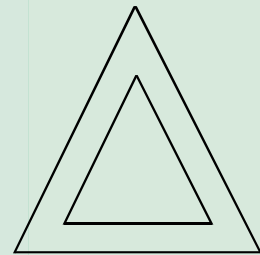
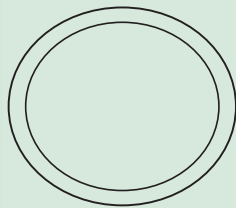

MS-polymer herder alltid fra utsiden og inn mot midten.

Quality makes the pro.



Relekta AS



PÅFØRING

ANBEFALTE FUGEDIMENSJONER for elastiske fugemasser med 25% dilatasjon

Fugelengde	Minimum bredde			Fugedybde		
	Betong, Kunstig stein	Alu	PVC	Betong, Kunstig stein	Alu	PVC
1 m	6 mm	10 mm	20 mm	6 mm	6 mm	10 mm
2 m	8 mm	15 mm	40 mm	8 mm	10 mm	20 mm
3 m	12 mm	25 mm	-	10 mm	15 mm	-
4 m	15 mm	30 mm	-	10 mm	15 mm	-
6 m	25 mm	-	-	15 mm	-	-
10 m	40 mm	-	-	20 mm	-	-

Man må øke verdiene for mørke vegger, ekstreme temperaturer og andre unormale forhold. Tommelfingerregel; fugedybde = 2/3 av fugebredde.

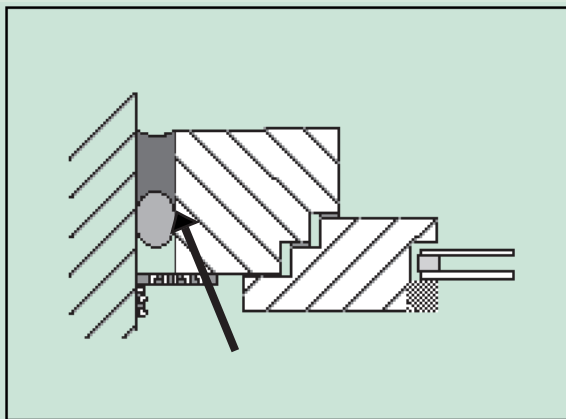

Feil, fugedimensjonen må aldri være slik at dybden er større enn bredden!

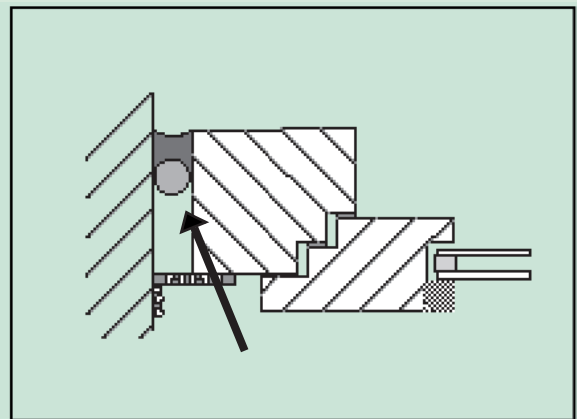

Riktig!

Quality makes the pro.



Relekta AS



PÅFØRING

VEDHEFT

Fugemassen må henge fast på 2 motstående sider.

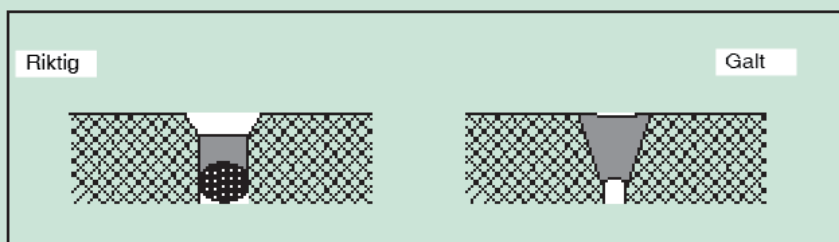
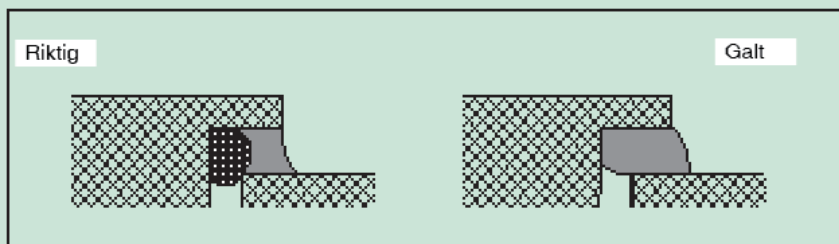
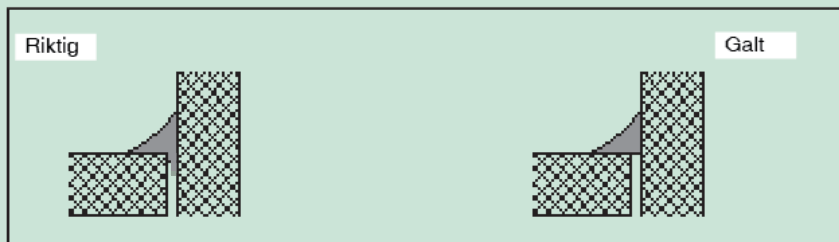
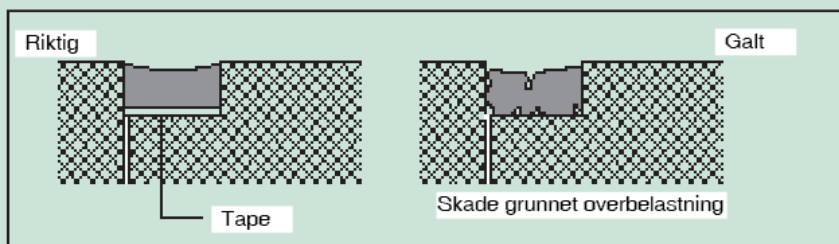

Quality makes the pro.



Relekta AS



Optimal fugepistol

Et godt verktøy gir et optimalt fugeresultat. En fugepistol med høy kraftoverføring gjør at man trenger mindre krefter for å trykke ut fugemassen av patronen. Det gjør det enklere å fuge jevnt.

Enkle fugepistoler har gjerne en kraftoverføring på 1:6 – 1:7. Vi anbefaler derfor TecGun som har en kraftoverføring på 1:18. TecGun har i tillegg roterende sylindere og stopp-funksjon som gjør at det ikke presses ut overflødig masse når man kommer til enden av fugeområdet.

Enkelte lim/fugemasser har en konsistens som krever en fugepistol med høy kraftoverføring, dette gjelder bl.a X-TACK7.



Quality makes the pro.



Releka AS



EGENSKAPER

Når man skal fuge eller lime er det viktig at produktet har de rette egenskapene. Blant annet er det viktig med fugemassens bestandighet mot;

- Temperatur
- UV
- Vann
- Klor
- Kjemikalier

Quality makes the pro.



Relekta AS



EGENSKAPER

Sammenligning egenskaper

	MS-polymer	Silikon	Polyuretan
UV-stabilitet	veldig bra	bra	moderat
Vannmotstand	veldig bra	veldig bra	bra
Lukt	lite	forskjellig	ofte sterk
Gjennomherding	veldig bra	veldig bra	bra
Kompatibilitet med Akryl maling	veldig bra	dårlig	oftest dårlig
Kompabilitet med alkydmaling	bra (avhengig av glansen til produktet)	dårlig	bra
Temperatur resistens	bra	veldig bra	bra
Klor resistens	dårlig	dårlig (stor variasjon på typene)	dårlig

Quality makes the pro.



Relekta AS



EGENSKAPER

TEMPERATUR RESISTENS



TEC7

TRANS7

X-TACK7

-40°C til +95°C

FLEX7

ROCK7

-45°C til +153°C

Quality makes the pro.



Relekta AS



EGENSKAPER

UV-STABILITET

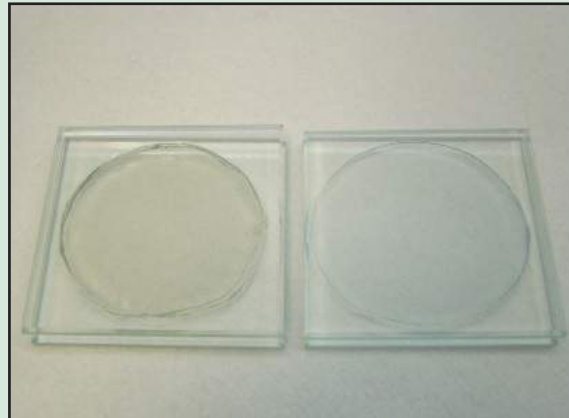

Bruk aldri TRANS7 på eller bak tykke glass som utsettes for sterk UV-stråling.

- Gulner
- Blir klissete

Bruk TEC7, FLEX7 eller ROCK7 for fugging i kombinasjon med glass!

Quality makes the pro.



Relekta AS



EGENSKAPER

VANNMOTSTAND

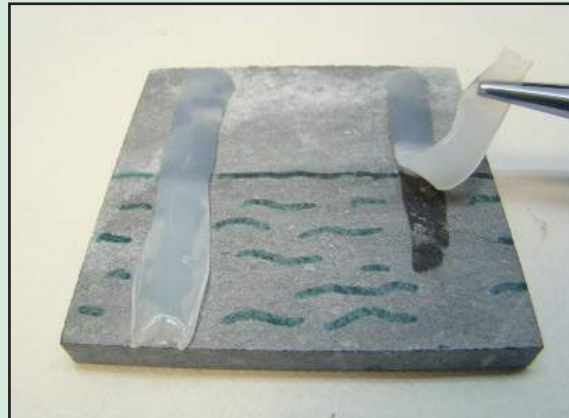

Hvis man legger tynne lag med fugemasse, vil det ikke gi noen varig vedheft ved nedsenking i vann.

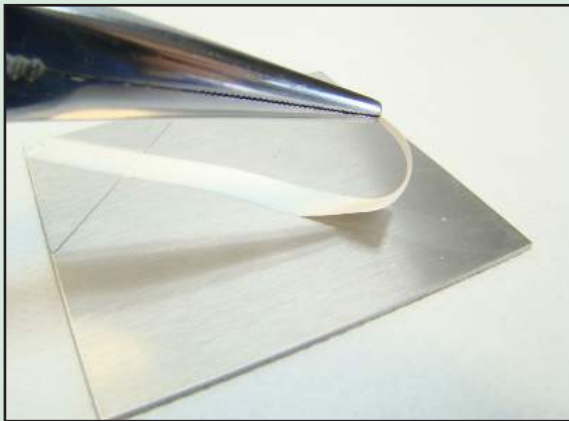

Tynt lag er ikke OK!

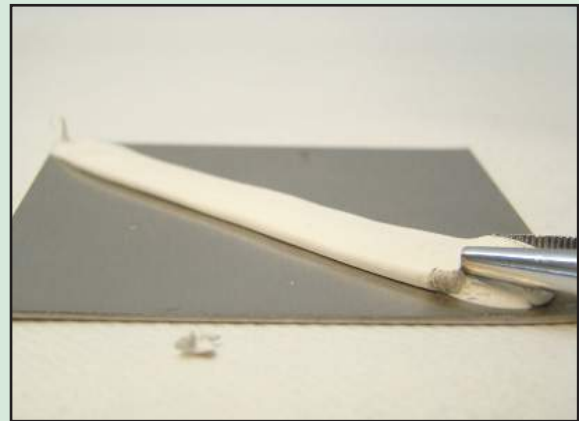

Tykk lag er OK!

Quality makes the pro.



Releka AS



EGENSKAPER

KLOR RESISTENS

MS-polymer er ikke resistent mot klor over lengre tid hvis produktet ligger kontinuerlig under vann!



Unngå 'sjokk-kloring'

Quality makes the pro.



Releka AS



EGENSKAPER

KJEMISK RESISTENS



Hvis fugen ikke er fullstendig herdet, når den utsettes for kjemikaliene, vil kjemikaliene angripe fugen og skade/løse opp fugen.



Hvis fugen er ferdig herdet (etter ca 7 dager) når den utsettes for kjemikalier, vil du få et godt resultat.

Quality makes the pro.



Releka AS



EGENSKAPER

Når man skal fuge eller lime er det viktig at produktet har de rette egenskapene. Blant annet er det viktig med limets;

- Forskyvningskraft
- Bruddspenning
- Underlag som løsner

Quality makes the pro.



Relekta AS



EGENSKAPER

FORSKYVNINGSKRAFT

Krefter som virker 90° mot underlaget.

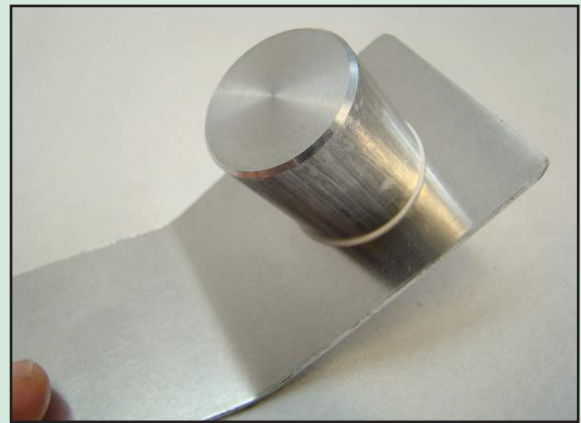
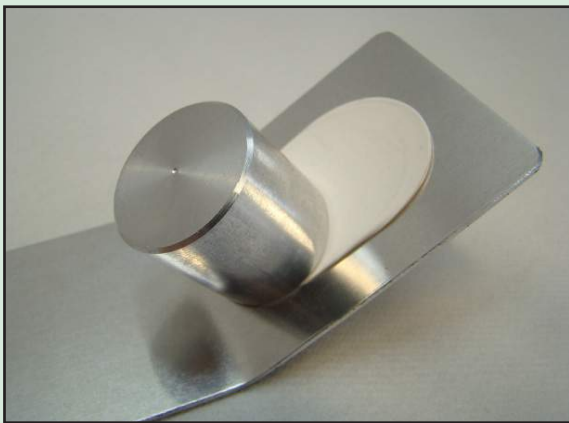

Quality makes the pro.



Relekta AS



EGENSKAPER

BRUDDSPENNING

F.eks når 2 limte plater trekkes rett fra hverandre som vist under.

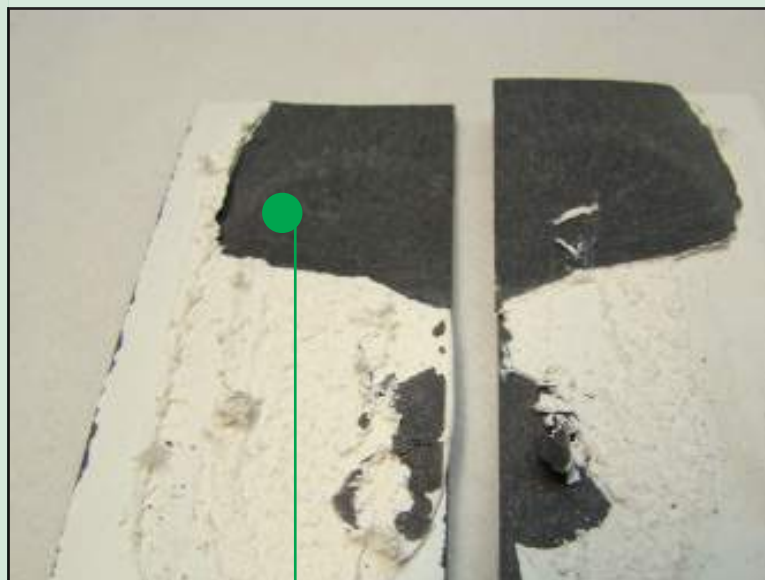

OK

Quality makes the pro.



Relekta AS



EGENSKAPER

UNDERLAG SOM LØSNER

Overflaten på produkt som limes må sitte godt fast til selve produktet.
F.eks plater med flere lag.

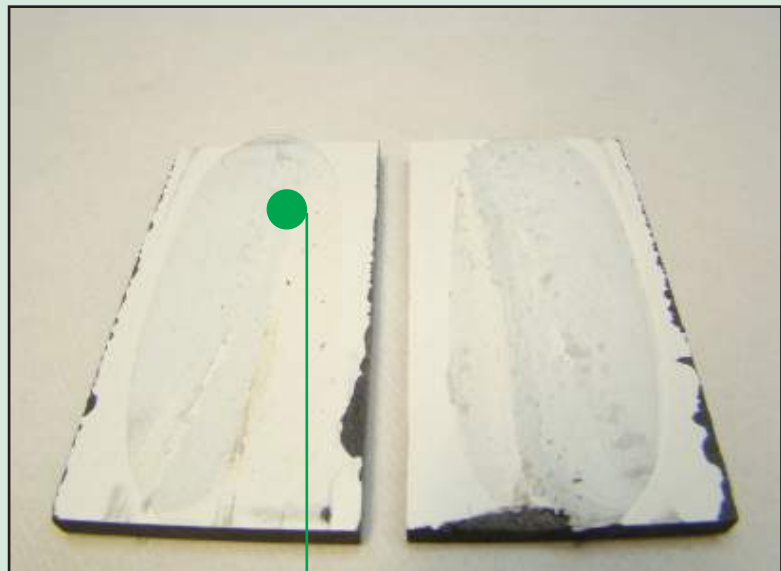

OK

Quality makes the pro.



Releka AS



FINPUSSEN

Den siste finpusser.



Quality makes the pro.



Relekta AS



FINPUSSEN

TEC7 Cleaner



Fugemasser med en jevn og glatt flate vil ha optimal betandighet mot ytre påvirkninger og optimal levetid. I tillegg vil den være enkel å rengjøre.

Quality makes the pro.



Relekta AS



FINPUSSEN

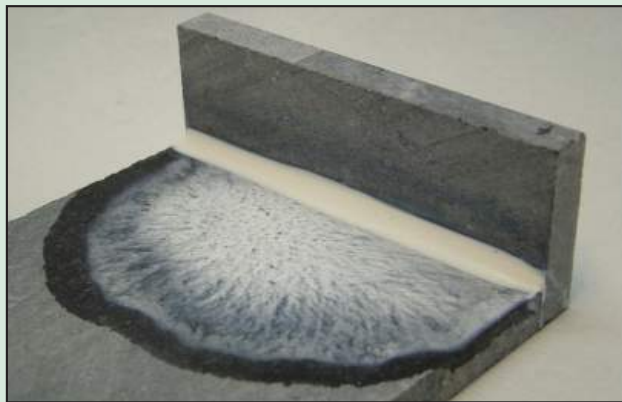

Alle løsemiddelbaserte rengjørere vil lage flekker på naturstein og porøse materialer når det brukes i store mengder.



Den perfekte løsningen er HP7 – dette produktet angriper verken fugemassen eller materialene.

Quality makes the pro.



Relekta AS

02.08.2011©Relekta AS • Tlf: 22 66 04 00 • E-post: post@novatech.as • www.novatech.as

Side 44



90% av feil i forbindelse med fugemasser skyldes en eller flere av følgende faktorer;

- Feil påføring
- Feil valg av fugemasse
- For dårlig forarbeide med materialene

Riktig valg av produkt, godt forarbeide med materialene og korrekt påføring sikrer et godt resultat!

LYKKE TIL!

Quality makes the pro.



Relekta AS

Notater:

Quality makes the pro.



Releka AS

Notater:

Quality makes the pro.



Releka AS

Les mer om våre
Novatech-produkter på:



www.novatech.as



RELEKTA
Vi gjør vedlikehold enklere...

Relekta AS

Telefon: 22 66 04 00

www.relekta.no • post@novatech.as